

NOTES

The following information relates to the product shown:

1. 80% total suspended solids (TSS) removal
2. 80% oil / grease removal
3. 190 gallons per minute (GPM) filtration rate before the built-in bypass
4. Ultra Urban Filter Drop-In (DI) will be attached to a custom collar based on catch basin specifications. Collar purchased separately.
5. DI1414H contains 10 lbs (+/- 10%) of Smart Sponge® media

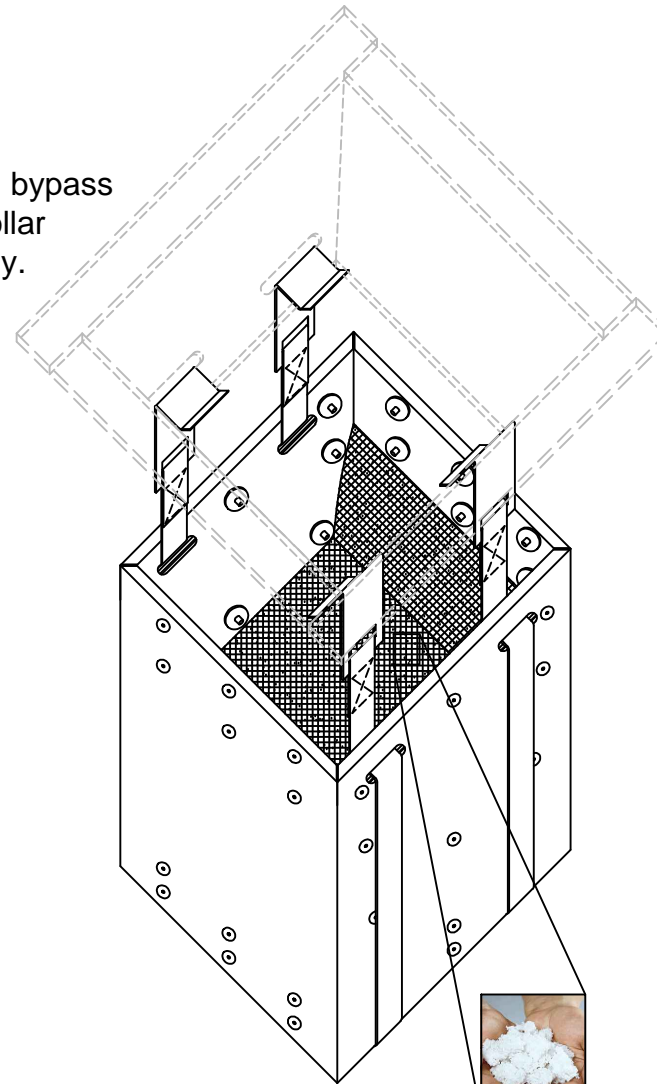
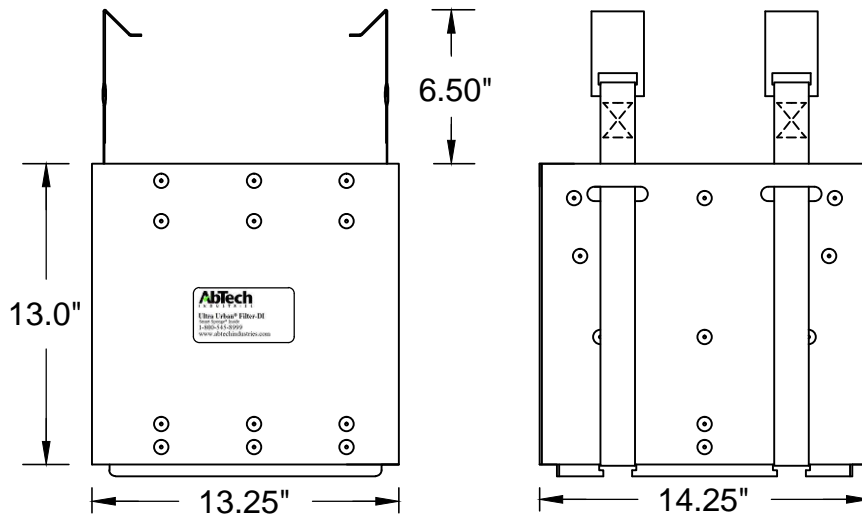

Smart Sponge® media



PROJECT NAME:		PROJECT CONTACT ENGINEER:	
LOCATION:		CONTACT:	
ULTRA URBAN DROP-IN (DI) SMART SPONGE® FILTER DI1414H		SITE MANAGER:	
 <p>These drawings are the property of Abtech Industries, Inc. Drawings may not be printed, reproduced or used without the prior written consent of Abtech Industries, Inc.</p>			
SCALE (FULL SCALE): 1.5 inches : 12 inches			
PROJECT ENGINEER:			
DRAWN BY: APB			
DESIGNED BY:			
CHECKED BY:			
ISSUE DATE: 01/17/2017			
PROJECT NO:			
SHEET TITLE: Ultra Urban Drop-In (DI) Smart Sponge® Filter - DI1414H			
SHEET NUMBER: 1			