

NOTES

The following information relates to the product shown:

1. 80% total suspended solids (TSS) removal
2. 80% oil / grease removal
3. 240 gallons per minute (GPM) filtration rate before the built-in bypass
4. Ultra Urban Filter Drop-In (DI) will be attached to a custom collar based on catch basin specifications. Collar purchased separately.
5. DI1616H contains 12 lbs (+/- 10%) of Smart Sponge® media

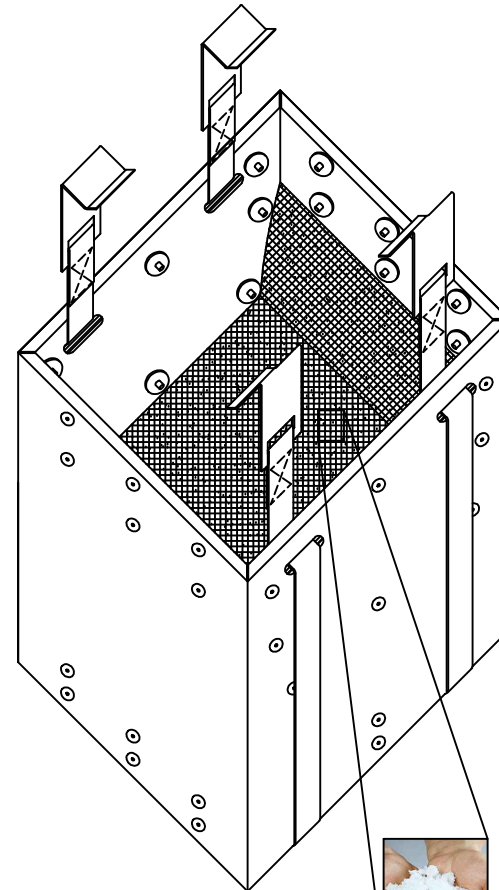
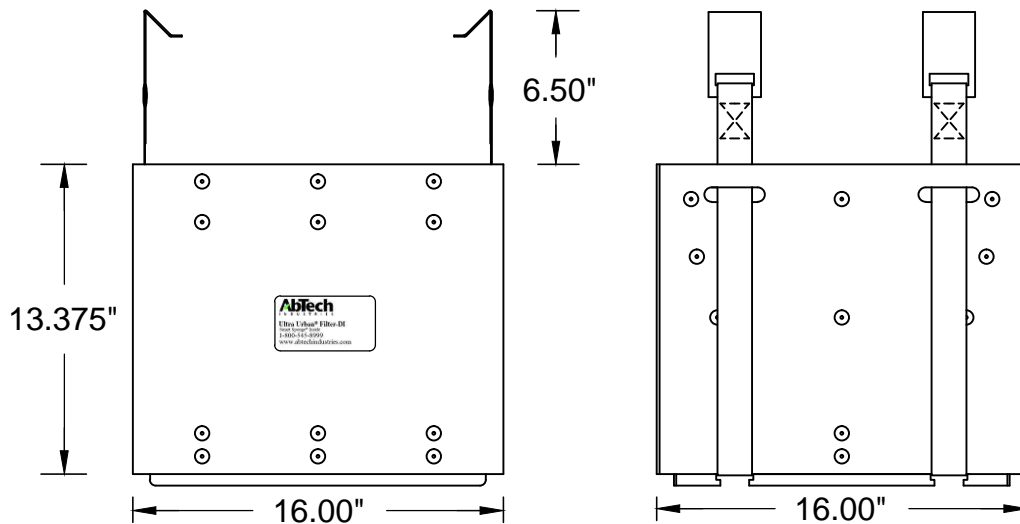

Smart Sponge® media

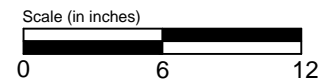

PROJECT NAME:	PROJECT CONTACT ENGINEER:	 <p>These drawings are the property of Abtech Industries, Inc. Drawings may not be printed, reproduced or used without the prior written consent of Abtech Industries, Inc.</p>
LOCATION:	CONTACT:	
ULTRA URBAN DROP-IN (DI) SMART SPONGE® FILTER DI1616H	SITE MANAGER:	<p>SCALE (FULL SCALE): 1.5 inches : 12 inches</p> <p>PROJECT ENGINEER:</p> <p>DRAWN BY: APB</p> <p>DESIGNED BY:</p> <p>CHECKED BY:</p> <p>ISSUE DATE: 01/17/2017</p> <p>PROJECT NO:</p> <p>SHEET TITLE: Ultra Urban Drop-In (DI) Smart Sponge® Filter - DI1616H</p> <p>SHEET NUMBER: 1</p>